





SKU: AB4112

-  VOLT Hygienic 3 Way Pneumatically Actuated Ball Valve
-  VOLT Hygienic 3 Way Pneumatisch betätigte Válvula de bola con
-  actuador VOLT Higiénico 3 , neumática
-  VOLT hygiénique 3 Way actionnement pneumatique Ball Valve

**Valves**<sup>™</sup>  
O N L I N E

- ½" - 4" Actuated 3 Way Sanitary Ball Valve
- ½" - 4" Betätigt 3-Wege- Kugelhahn Sanitary
- ½" - 4" Válvula de bola motorizadas 3 Way Sanitaria
- ½" - 4" Actionné 3 Way Ball Valve Sanitaires

3-Way L or T Port

TRI – Clamp  
OD Weld Ends



- 3 Way L and T Port
- No Dead Space in Through Path
- Encapsulated Hygienic Seats
- All Materials Comply with FDA Requirements
- Clamp and OD Weld End Connections
- Double Acting and Spring Return
- Fully Maintainable

#### Description:

VOLT range of pneumatically actuated 3 way sanitary ball valves, fulfil a wide variety of diverting hygienic applications. Available in spring return and double acting with either Plain weld OD or Tri Clamp ends, which exhibit high flow rates by virtue of the true tube full port, offering no dead space in the through path. All actuators are design to the latest ISO/Namur standards and are ATEX approved. End of Stroke adjustment ( $\pm 5^\circ$ ) is fitted as standard.

The ball valves are of 4 piece design (L or T Port) and fitted with encapsulated FDA approved PTFE seats, suitable for CIP cleaning.

In most cases the actuators fit directly onto the valves so no mounting kit is required, thus making the package more compact and cost effective.



#### Description

Pneumatically operated ultra pure 3 way (L or T port) ball valve in sizes from ½" to 4". Connections are either OD weld or Tri-clamp ends. The actuator comes in either Double Acting or Spring Return. The Valve is full bore and has fully encapsulated PTFE ball seats that are easily replaced for maintenance purposes. Pressures up to 1000 PSI and temperature Range -20° C to 180° C.



#### Beschreibung

Pneumatisch betätigt ultrareinem 3-Wege (L oder T -Anschluss ) Kugelhahn in den Größen von ½ "bis 4" . Die Anschlüsse sind entweder OD Schweiß- oder Tri-Clamp endet . Der Antrieb kommt entweder doppelwirkend oder mit Federrückstellung . Das Ventil wird mit vollem Durchgang und ist vollständig gekapselt PTFE Kugelsitze , die leicht zu Wartungszwecken ausgetauscht werden . Drücke bis zu 1000 PSI und Temperaturbereich -20 ° C bis 180 ° C







#### descripción

De accionamiento neumático de ultra pura de 3 vías ( L o conexión T ) válvula de bola en tamaños de ½ "a 4" . Las conexiones son bien OD soldadura o Tri -clamp termina . El actuador viene en doble efecto o retorno por muelle . La válvula es de paso total y ha encapsulado totalmente asientos de bola PTFE que se reemplazan fácilmente para fines de mantenimiento . Las presiones hasta 1000 PSI y de la temperatura Rango -20 ° C a 180 ° C..



#### description

Commande pneumatique ultra pur 3 voies ( L ou le port T ) vanne à bille dans les tailles de ½ "à 4" . Les connexions sont soit soudure OD ou Tri-clamp se termine . L'actionneur vient en soit double effet ou à ressort de rappel . La vanne est plein alésage et a entièrement encapsulé de sièges en PTFE qui sont facilement remplacés à des fins de maintenance . pressions jusqu'à 1000 PSI et de la température -20 ° C à 180 ° C

-  VOLT Hygienic 3 Way Pneumatically Actuated Ball Valve
-  VOLT Hygienic 3 Way Pneumatisch betätigte Vávula de bola con
-  actuador VOLT Higiénico 3 , neumática
-  VOLT hygiénique 3 Way actionnement pneumatique Ball Valve



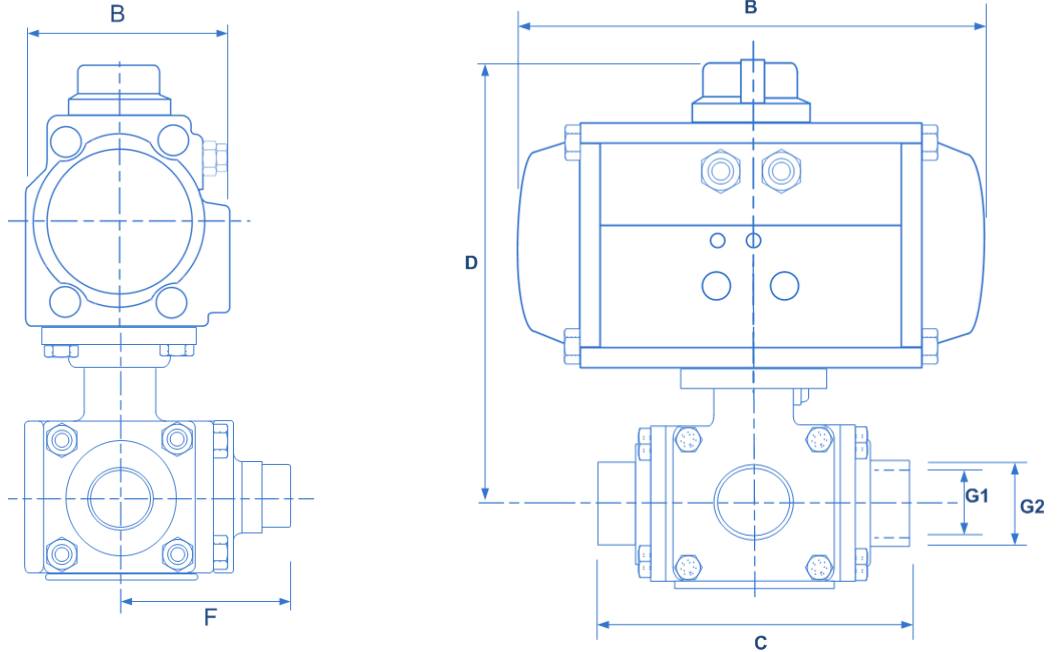

## Plain OD Weld Ended 3 Way Pneumatic Ball Valve

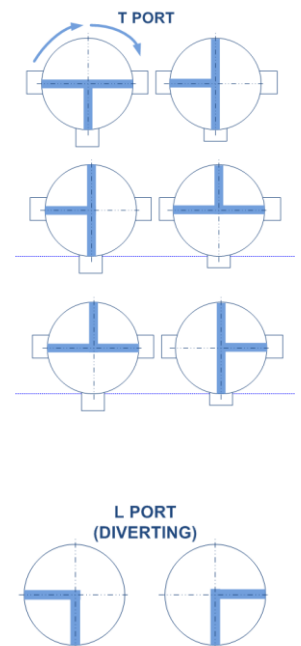

Dimensions								
Valve	Spring Return	A	B	C	D	F	G1	G2
1/2" (15mm)	HP88S	247	108	120	174	60	9.6	12.7
3/4" (20mm)	HP88S	24	108	136	177	68	15.8	19.1
1" (25mm)	HP115S	336	141	160	221	80	22.1	25.4
1 1/2" (40mm)	HP125S	347	151	182	253	91	34.8	38.1
2" (50mm)	HP145S	454	172	215	302	108	47.5	50.8
2 1/2" (65mm)	HP200S	555	227	241	421	121	60.2	63.5
3" (80mm)	HP200S	555	227	280	439	139	72.9	76.2
4" (100mm)	HP210S	628	236	330	468	165	97.4	102

Dimensions								
Valve	Double Acting	A	B	C	D	F	G1	G2
1/2" (15mm)	HP63D	163	85	120	146	60	9.6	12.7
3/4" (20mm)	HP63D	163	85	136	148	68	15.8	19.05
1" (25mm)	HP75D	210	96	160	179	80	22.1	25.4
1 1/2" (40mm)	HP88D	247	108	182	210	91	34.8	38.1
2" (50mm)	HP100D	288	123	215	259	108	47.5	50.8
2 1/2" (65mm)	HP145D	414	172	241.3	353	121	60.2	63.5
3" (80mm)	HP145D	414	172	280	371	139	72.9	76.2
4" (100mm)	HP160D	467	190	330	458	165	97.4	101.6



-  VOLT Hygienic 3 Way Pneumatically Actuated Ball Valve
-  VOLT Hygienic 3 Way Pneumatisch betätigte Vávula de bola con
-  actuador VOLT Higiénico 3 , neumática
-  VOLT hygiénique 3 Way actionnement pneumatique Ball Valve



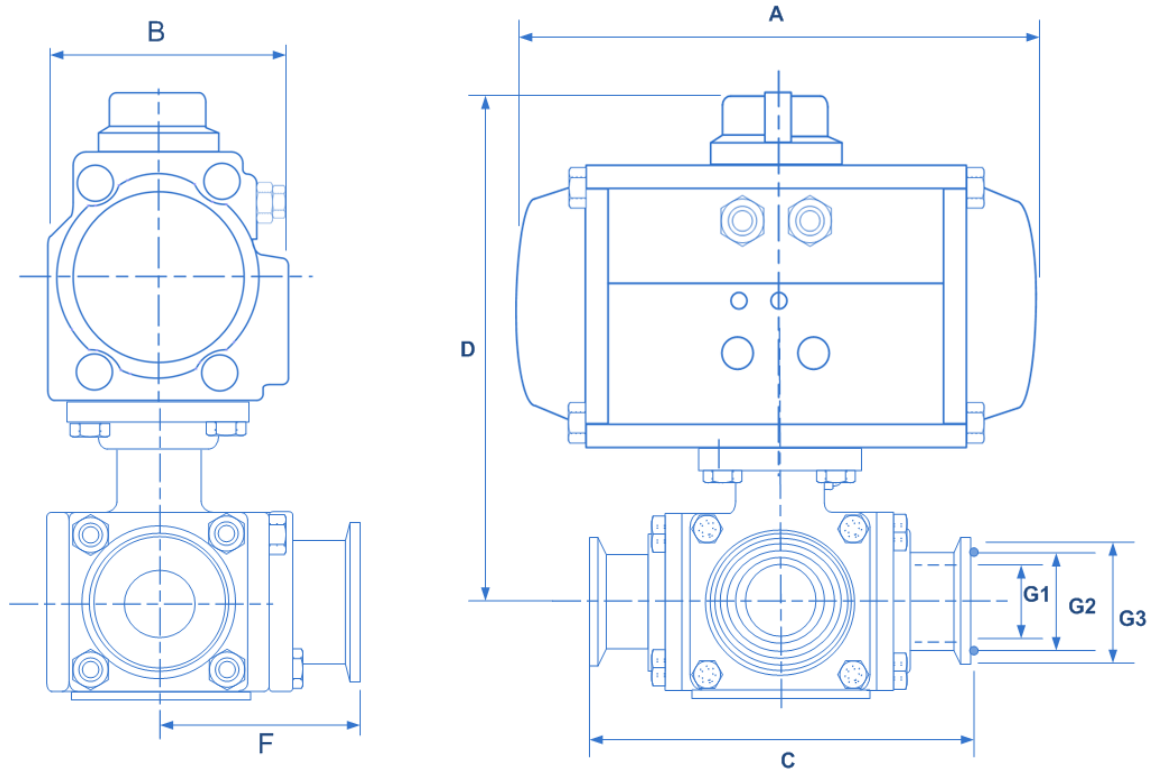

## Tri - Clamp Ended 3 Way Pneumatic Ball Valve

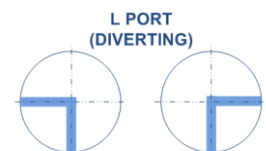
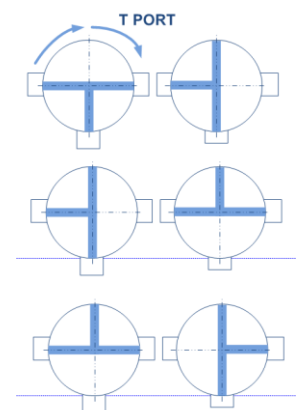

Dimensions								
Valve	Spring Return	A	B	C	D	F	G1	G2
1/2" (15mm)	HP88S	247	108	133	174	66.5	9.6	21.7
3/4" (20mm)	HP88S	247	108	142	177	71	15.8	21.7
1" (25mm)	HP115S	336	141	160	221	80	22.1	43.5
1 1/2" (40mm)	HP125S	347	151	182	253	91	34.8	43.5
2" (50mm)	HP145S	454	172	216	302	108	47.5	56.5
2 1/2" (65mm)	HP200S	555	227	241	421	120	62	60.2
3" (80mm)	HP200S	555	227	279	439	140	76	72.9
4" (100mm)	HP210S	628	236	330	468	165	96	97.4

Dimensions									
Valve	Double Acting	A	B	C	D	F	G1	G2	G3
1/2" (15mm)	HP63D	163	85	133	146	66.5	9.6	21.7	25
3/4" (20mm)	HP63D	163	85	142	148	71	15.8	21.7	25
1" (25mm)	HP75D	210	96	160	179	80	22.1	43.5	50.4
1 1/2" (40mm)	HP88D	247	108	182	210	91	34.8	43.5	50.4
2" (50mm)	HP100D	288	123	216	259	108	47.5	56.5	63.9
2 1/2" (65mm)	HP145D	414	172	241	353	120	62	60.2	77.4
3" (80mm)	HP145D	414	172	279	371	140	76	72.9	91
4" (100mm)	HP160D	467	190	330	458	165	96	97.4	119



-  VOLT Hygienic 3 Way Pneumatically Actuated Ball Valve
-  VOLT Hygienic 3 Way Pneumatisch betätigte Vávula de bola con
-  actuador VOLT Higiénico 3 , neumática
-  VOLT hygiénique 3 Way actionnement pneumatique Ball Valve

## Hygienic 3 Way Actuated ball valve

Technical - Actuator	
Body material	Hard anodised extruded aluminium alloy
End Caps	Die cast aluminium epoxy coated
Spring	High tensile steel
Indicator	Open/Closed
Pinion shaft	Alloy steel nickle plated
Pinion Guides	Self Lubricating Polypropylene + GF
Piston seals	NBR steel
Specification	
Pressure range	10 Bar
Double acting	2.5 Bar - 8 Bar
Single acting - Open or Close	2.5 Bar - 8 Bar
Temperture range	minus 20°C - 80°C
Movement	90 Degree adjustable -5-+5 Degree
Lubrication	All moving parts are lubricated
Cycle Life	1,000,000 operations
Approvals	ATEX, CE, PED



Switch box and Solenoids fitted to complete the perfect valve



Sanitary ball valves

Valves Technical and Parts List	
Part Name	Material
Body	CF8M
End Cap	CF8M
Ball	SUS316
Stem	SUS316
Stem Nut	SUS304
Thrust Washer	SUS304
Handle	SUS304
Seat	Cavity Filled PTFE
Gland Ring	SUS304
Stem Packing	PTFE
Belleville washer	SUS304
Nut	SUS304
Specification	
Pressure range	1/2" to 2" 1000 PSI 2 1/2" - 4" 800 PSI
Size	1/2" to 4"
Temperature range	minus 20° to + 180° (see graph)
Movement	90 deg turn
Cycle life	1,000,000 operations



Pneumatic sanitary butterfly valves, complete actuated hygienic essentials