





SKU: BV5168

-  Mars Series 88 Ball Valve - FSAS
-  Mars Serie 88 Kugelhahn - FSAS
-  Serie Mars válvula de bola 88 - FSAS
-  Mars Series 88 Ball Valve - FSAS

**Valves**<sup>™</sup>  
O N L I N E

- 1/4 " - 4" Heavy duty three piece ball valve
- 1/4 "- 4" Schwerlast drei Stück Kugelhahn
- 1/4 " - 4" Para trabajo pesado de tres piezas válvula de bola
- 1/4 " - 4" Heavy duty trois pièces vanne à boisseau sphérique



- 3 Piece Encapsulated Body Bolts
- Firesafe and Anti-Static
- Heavy Duty High Performance Ball Valve
- Body in Carbon Steel
- ISO Mounting Pad for Easy Actuation
- Pressure Rating up to 2000 PSI
- ATEX Approved

MARS Series 88 heavy duty 3 piece ball valve, Reduced or Full bore supplied in carbon steel and fitted with carbon filled reinforced PTFE seats and seals. The valve has a unique encapsulated body bolt design and offers a raised ISO mounting pad with a square stem top for direct mounting for actuation. A Lockable lever can be supplied for manual operation. The body seals can be replaced/maintained in line by dropping the swing out body without disassembly.

This valve is **Fire safe and Antistatic**. Ends come in either BSPP, NPT, Socket Weld and Butt weld (SCHD 40)

**MARS Series 88 Carbon Steel Ball Valve**

**FIRE SAFE AND ANTI - STATIC**  
API 607 4<sup>th</sup> Edition Certified



#### Description

Mars series 88 is a high performance ball valve that is fully maintainable. Offered in full or reduced bore with a raised direct mount ISO pad for actuation.

1/4" - 1" - 2000 PSI  
1 1/4" - 2" - 1500 PSI  
2 1/2" - 4" - 1000 PSI



#### Beschreibung

Mars Serie 88 ist ein Hochleistungs-Kugelhahn, die voll wartbar ist. Mit einem erhöhten Direktanbau ISO -Pad zur Ansteuerung Angeboten in voller oder reduzierter Bohrung.

1/4" - 1" - 2000 psi  
1 1/4" - 2" - 1500 psi  
2 1/2" - 4" - 1000 PSI



#### Descripción

Mars serie 88 es una válvula de bola de alto rendimiento que es totalmente mantenible. Se ofrece en paso total o reducido con una almohadilla de montaje ISO directa planteado para el accionamiento.





1/4" - 1" - 2000 PSI  
1 1/4" - 2" - 1500 PSI  
2 1/2" - 4" - 1000 PSI



#### Description

Série Mars 88 est une vanne à boisseau sphérique de haute performance qui est entièrement maintenable. Offert en passage intégral ou réduit avec un tampon directe soulevé montage ISO pour l'actionnement.

1/4" - 1" - 2000 PSI  
1 1/4" - 2" - 1500 PSI  
2 1/2" - 4" - 1000 PSI

-  Mars Series 88 Ball Valve - FSAS
-  Mars Serie 88 Kugelhahn - FSAS
-  Serie Mars válvula de bola 88 - FSAS
-  Mars Series 88 Ball Valve - FSAS



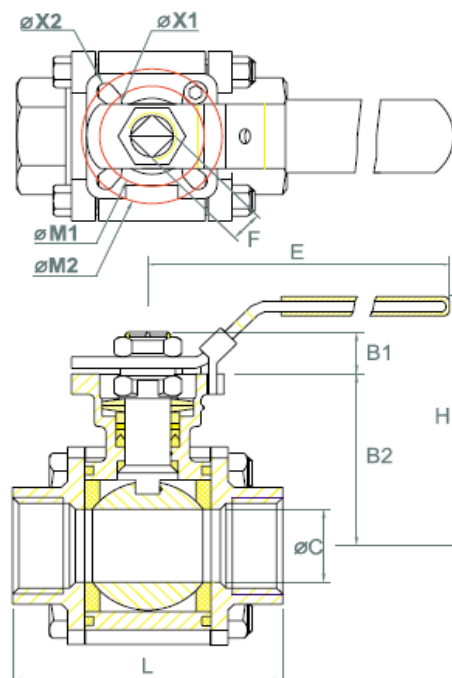
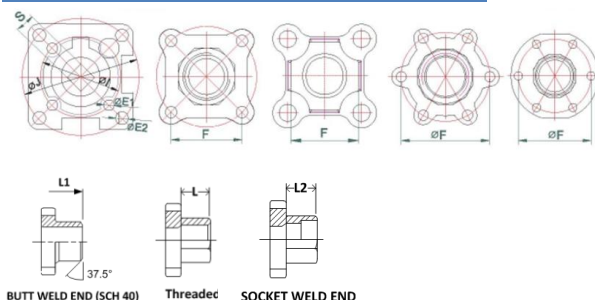

### Mars series 88 ball valve

BREAKAWAY TORQUE & C.V.					
Size		Break Away Torque N/M		C.V. (G.P.M.)	
inches	DN	Full	Red.	Full	Red.
1/4"	8	8	8	8	8
3/8"	10	8	8	8	8
1/2"	15	8	8	15	8
3/4"	20	10	10	34	15
1"	25	16	10	56	34
1 1/4"	32	23	16	85	56
1 1/2"	40	33	23	125	85
2"	50	47	33	250	125
2 1/2"	65	62	47	320	250
3"	80	101	62	580	350
4"	100	114	101	1020	580



Dimensions Reduced Bore										
Size	L	L1	L2	B1	B2	H	E	F	ISO 5211	Weight
1/4"	USE FULL BORE									
3/8"	USE FULL BORE									
1/2"	72.5	75	10	6.4	42.6	78	139	9	F03 & F04	0.89
3/4"	72.5	74.8	13	6.4	42.6	78	139	9	F03 & F04	0.82
1"	85.4	89.8	13	8.5	46.9	82.6	139	9	F03 & F04	1.29
1 1/4"	105.3	109.4	13	10.4	59.3	98.5	165	11	F04 & F05	2.01
1 1/2"	111	114.4	13	10.4	62.6	101.8	165	11	F04 & F05	2.76
2"	127.3	142.8	16	13.4	79	127	215	14	F05 & F07	4.21
2 1/2"	142.8	185	16	13.4	87.7	135.6	215	14	F05 & F07	5.83
3"	185	205	16	16.8	108.7	167	262	17	F07 & F10	12
4"	205	240	20	17.8	117.7	176	262	17	F07 & F10	16.2

Dimensions Full Bore										
Size	L	L1	L2	B1	B2	H	E	F	ISO 5211	Weight
1/4"	72.5	75	10	6.4	42.6	78	139	9	F03 & F04	0.89
3/8"	72.5	75	10	6.4	42.6	78	139	9	F03 & F04	0.89
1/2"	72.5	75	10	6.4	42.6	78	139	9	F03 & F04	0.82
3/4"	85.4	90	13	8.6	46.9	82.6	139	9	F03 & F04	1.29
1"	105.3	110	13	10.4	59.3	98.5	165	11	F04 & F05	2.01
1 1/4"	111	115	13	10.4	62.6	101.8	165	11	F04 & F05	2.76
1 1/2"	127.3	130	13	13.4	79	127	215	14	F05 & F07	4.21
2"	142.8	143	16	13.4	87.7	135.6	215	14	F05 & F07	5.83
2 1/2"	185	185	16	16.8	108.7	167	262	17	F07 & F10	12
3"	205	205	16	17.8	117.7	176	262	17	F07 & F10	16.2
4"	240	240	20	16.8	133.7	192.7	312	17	F07 & F10	25.8

-  Mars Series 88 Ball Valve - FSAS
-  Mars Serie 88 Kugelhahn - FSAS
-  Serie Mars válvula de bola 88 - FSAS
-  Mars Series 88 Ball Valve - FSAS

## Mars series 88 ball valve

- Firesafe and Anti-Static
- 3 Piece Encapsulated Body Bolts
- Heavy Duty High Performance Ball Valve
- Body in Carbon Steel
- ISO Mounting Pad for Easy Actuation
- Pressure Rating up to 2000 PSI
- ATEX Approved

### End connection Options

Socket Weld  
Butt Weld (sch40)  
NPT and BSPP

### Options

Stainless Steel filled PTFE seats  
V Sector Balls  
Switches Fitted  
Spring Closed Handle

ATEX 94/9/EC  
CE – 0035  
PED/97/23/EC



Technical and Parts List			
No.	Part Name	Material	Qty
1	Body	ASTM A351	1
2	End Cap	ASTM A351	2
3	Ball	SUS316	1
4	Stem	SUS316	1
5	Stem Nut	SUS304	1
6	Belleville washer	SUS301	1
7	Handle	SUS304	1
8	Ball Seat	Carbon Filled PTFE	2
9	Gland	SUS304	1
10	V-Ring Packing	MG1241	1
11	Stem Seal	Carbon Filled PTFE	1
12	Lock Saddle	SUS304	1

Specification	
Pressure range	1/4" to 1" 2000 PSI 1 1/4" to 2" 1500 PSI 2 1/2" to 4" 1000 PSI
Size	1/4" to 4" Full Bore, 1/2" to 4" Reduced Bore
Temperature range	minus 20° to + 200° (see graph)
Movement	90 deg turn
Cycle life	1,000,000 operations
Standard Approvals	Fire-Safe Certified to API 607 4th Edition
Options	TA-Luft, NACE MR-0175,



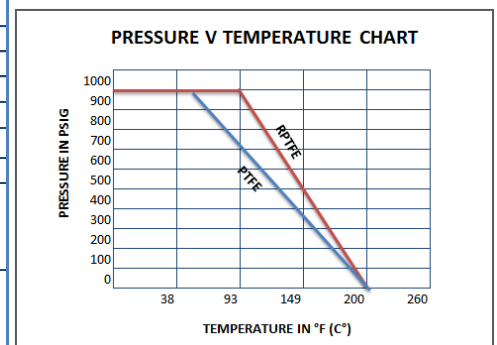



Bore or Port Dimensions of Valves											
Size	1/4"	3/8"	1/2"	3/4"	1"	1 1/4"	1 1/2"	2"	2 1/2"	3"	4"
ØF Full	38.2	38.2	38.2	44.3	50	57.2	66.6	114	139	160	193
ØF Reduced	X	X	38.2	38.2	44.3	50	57.2	66.6	114	139	160



Type AP9001 ATEX  
Pneumatic Actuator



Type AP9004  
Explosion Proof  
Electric Actuator

-  Mars Series 88 Ball Valve - FSAS
-  Mars Serie 88 Kugelhahn - FSAS
-  Serie Mars válvula de bola 88 - FSAS
-  Mars Series 88 Ball Valve - FSAS

## Mars series 88 ball valve

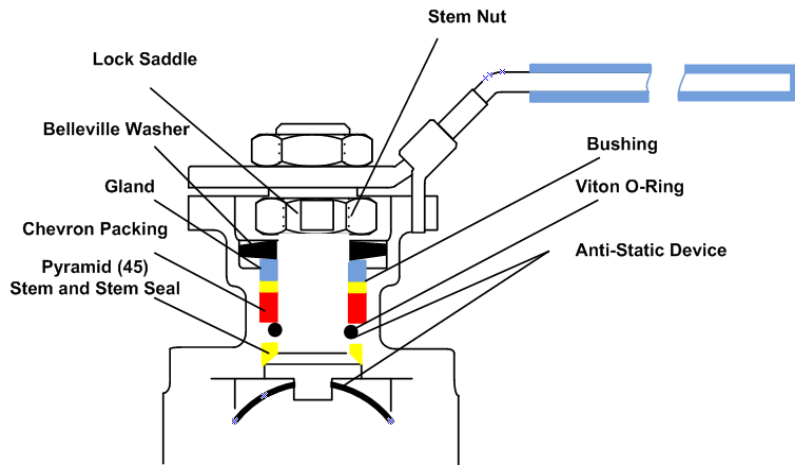

### Mars Unique SealMax Tripple Sealing Stem Packing System Live Loaded Maintenance Free Extra Long Cycle Life TA Luft Approved

1. Pyramid Stem wth Stem Seal
2. V Ring Stem Packing
3. Lock Saddle
4. Stem Nut
5. Belleville Washers
6. Gland
7. Anti-Static Device
8. Super Smooth Stem Finish