





SKU: BV5130

-  Mars Series 33 - Diverting 3 Way Ball Valve
-  Mars Serie 33 - Umleiten 3 Wege Kugelhahn
-  Mars Serie 33 - Desvío de 3 Válvula de bola Camino
-  Mars Série 33 - Détourner 3 Way Ball Valve

Valves[™]
O N L I N E

- 1/4 " - 4" Direct Mount 3 Way L or T Port ball Valve
- 1/4 " - 4" 3-Wege- Direktmontage L oder T-Anschluss -Kugelhahn
- 1/4 " - 4" de 3 vías montaje directo L o puerto T válvula de bola
- 1/4 " - 4" Montage direct 3 Way L Orr T Port balle Valve



- **Live Loaded Chevron PTFE Gland Packing**
- **Direct Mount Pad**
- **Full Bore**
- **Various End Connections**
- **L or T Flow Paths for Diverting**

Description

3 Way L or T Port, full bore ball valve. body material in CF8M/316, with 5 seat design reinforced PTFE and live loaded chevron PTFE gland packing. This direct mount valve is suitable for manual or for automatic actuation, offering superior performance and reliability. Pressure rating 1000 PSI and temperatures up to 200°C. Connections are Screwed BSP or NPT, Butt or Socket Weld and flanged PN16 or ANSI 150.

Available in either L port (Diverter Valve) or T port.

Mars Series 33 Multi-Port Ball Valve

**BSP, NPT, Socket and
Butt Weld**



Description

Full Bore Stainless Steel 3 Way Ball Valve. The flow paths are in L or T configuration and offers a low torque. Easily actuated because of the ISO direct mount pad.

Temperature Range -20°C to 200°C.

Operating pressure: 1/4" to 1" 1000 PSI, 1 1/4" to 2" 800 PSI and 2 1/2" to 4" 600 PSI



Beschreibung

Vollbohrung Edelstahl 3 Wege Kugelhahn . Die Strömungswege in L- oder T-Konfiguration und bietet ein niedriges Drehmoment . Leicht wegen der ISO Direktmontage Pad angesteuert.

Temperaturbereich -20 ° C bis 200 ° C .

Betriebsdruck : 1/4 "bis 1" 1000 psi , 1 1/4 "bis 2" 800 PSI und 2 1/2 "bis 4" 600 PSI



Descripción

Bore completa de acero inoxidable Válvula de bola de 3 vías . Las trayectorias de flujo están en configuración L o T y ofrece un par motor bajo . Fácilmente accionado por el pad directa ISO montura.

Rango de temperatura de -20°C a 200°C .

Presión de trabajo : 1/4 "a 1 " 1000 PSI , 1 1/4 "a 2 " 800 PSI y 2 1/2 "a 4 " 600 PSI







Description

Full Bore Stainless Steel 3 Way Ball Valve . Les trajets d'écoulement sont en configuration L ou T et offre un couple à bas régime .

Facilement actionné en raison de la garniture à montage direct ISO . Gamme

Température -20°C à 200°C .

Pression de service : 1/4 "à 1" 1000 PSI , 1 1/4 "à 2" 800 PSI et 2 1/2 "à 4" 600 PSI



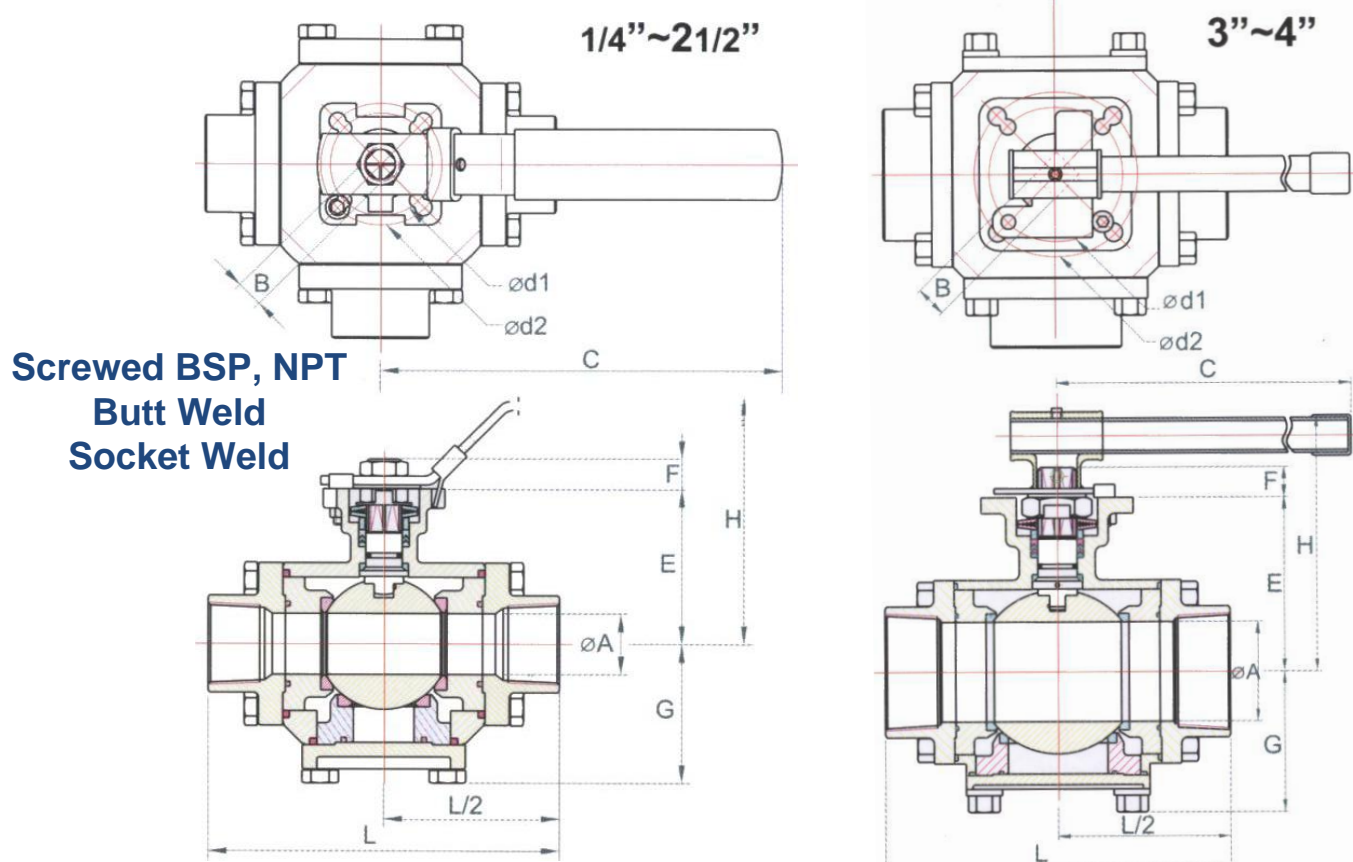

-  Mars Series 33 - Diverting 3 Way Ball Valve
-  Mars Serie 33 - Umleiten 3 Wege Kugelhahn
-  Mars Serie 33 - Desvío de 3 Válvula de bola Camino
-  Mars Série 33 - Détourner 3 Way Ball Valve

MARS Series 33 Ball Valve



Dimensions

Size	A	B	C	E	F	G	H	L	d1	d2	W(kg)	ISO5211
1/4"	11.6	9	150	43.9	9	35.1	85	92	36	42	1.4	F03/F04/F05
3/8"	12.7	9	150	43.9	9	35.1	85	92	36	42	1.4	F03/F04/F05
1/2"	15	9	150	43.9	9	35.1	85	92	36	42	1.3	F03/F04/F05
3/4"	20	11	165	54.2	10.5	45.3	93	110	42	50	2.81	F04/F05
1"	25	11	180	64.1	10.5	56.8	108	144	42	50	4.76	F04/F05/F07
1 1/4"	32	14	215	78.5	13	59.8	127	146	50	70	5.75	F05/F07
1 1/2"	38	17/19	263	94.9	18	72.3	152	164	70	102	10.56	F07/F10
2"	50	17/19	313	101.6	18	80.5	159	184	70	102	13.42	F07/F10
2 1/2"	65	17/19	344	120	18	96.8	177	236	70	102	21.31	F07/F10
3"	76	22	370	132.9	23	105	195	265	102	125	28.85	F10/F12
4"	100	22	510	164	23	131.5	226	317	102	125	57.51	F10/F12

-  Mars Series 33 - Diverting 3 Way Ball Valve
-  Mars Serie 33 - Umlenken 3 Wege Kugelhahn
-  Mars Serie 33 - Desvío de 3 Válvula de bola Camino
-  Mars Série 33 - Détourner 3 Way Ball Valve

MARS Series 33 Ball Valve

Materials			
No.	Part Name	Material	Qty
1	Body	ASTM A351 Gr. CF8M	1
2	End Cap A	ASTM A351 Gr. CF8M	3
3	End Cap B	ASTM A351 Gr. CF8M	2
4	Stem Retainer	ASTM A351 Gr. CF8M	5
5	Ball	SUS316	1
6	Seat	PTFE/RTFE	5
7	Joint Gasket	PTFE	5
8	Stem Seal	PTFE	1
9	Stem	SUS316	1
10	Gland Packing	25% Glass Fibre Filled + PTFE	SET
11	Gland Bush	SUS304	1
12	Belleville Washer	SUS301	2
13	Stop Washer	SUS304	1
14	Stem Nut	SUS304	2
15	Stem Washer	SUS304	1
16	Retainer Seal	PTFE	5
17	Handle	SUS304	1
18	Handle Sleeve	Vinyl	1
19	Locking Device	SUS304	1
20	Bolt Nut	SUS304	20
21	Pin Nut	SUS304	1
22	Stop Pin	SUS304	1
23	O-Ring	VITON	1
24	Antistatic Device	SUS304	#

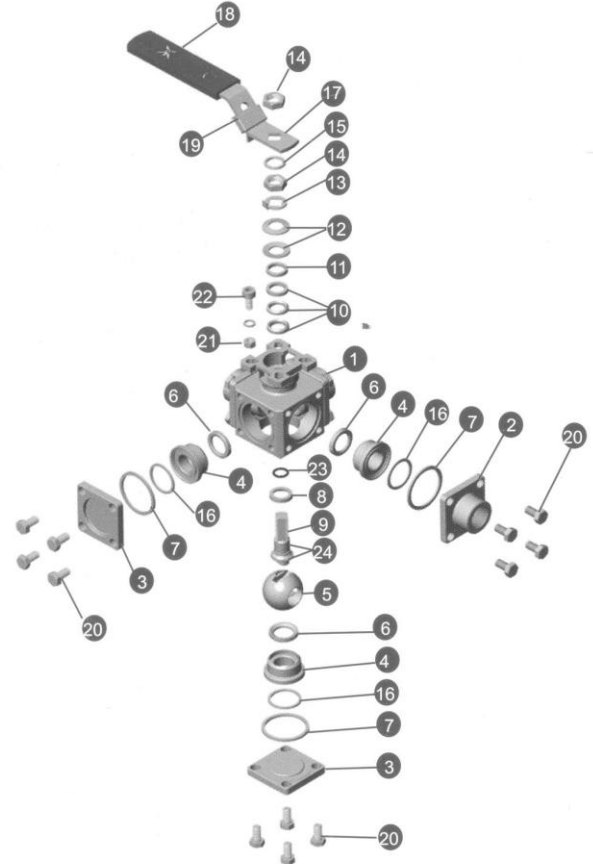

Break Away Torque





Valve Size		R-PTFE Seats	
Inches	DN	Nm	Inch-Lb
1/4"	8	8	75
3/8"	10	8	75
1/2"	15	8	75
3/4"	20	17	150
1"	25	36	325
1 1/4"	32	42	370
1 1/2"	40	68	600
2"	50	94	840
2 1/2"	65	25	1100
2"	80	198	1750
4"	100	250	2250

30% safety factor included, standard Mars Valves are assembled with silicon free based lubricant; torques for dry assembled valves please call us.

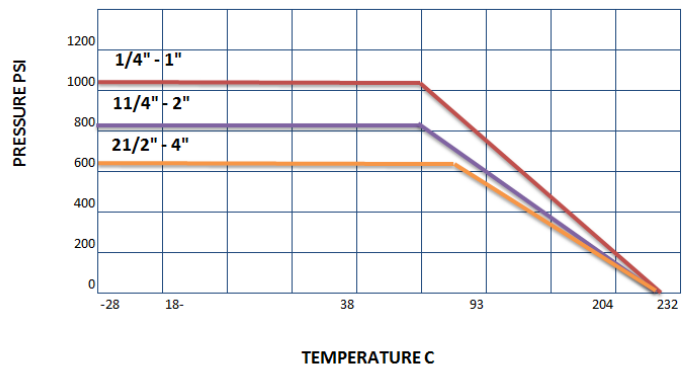
PRESSURE / TEMPERATURE CHART

RPTFE SEATS



-  Mars Series 33 - Diverting 3 Way Ball Valve
-  Mars Serie 33 - Umleiten 3 Wege Kugelhahn
-  Mars Serie 33 - Desvío de 3 Válvula de bola Camino
-  Mars Série 33 - Détourner 3 Way Ball Valve

MARS Series 33 Ball Valve

■ FLOW PATTERNS

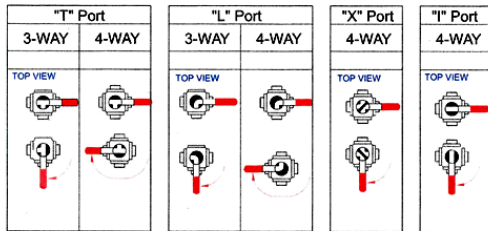

SERIES 33

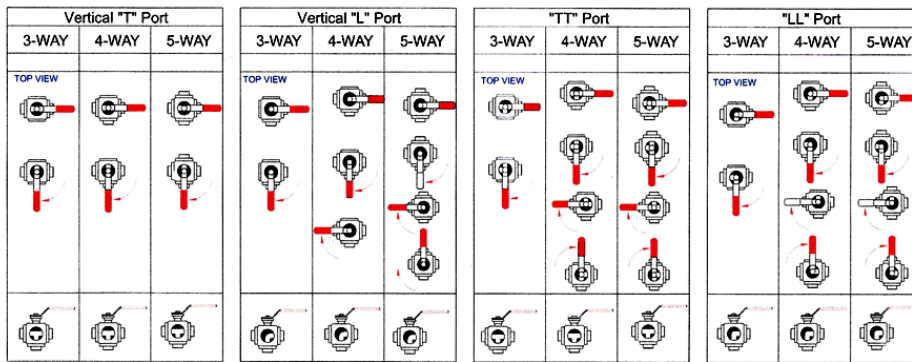
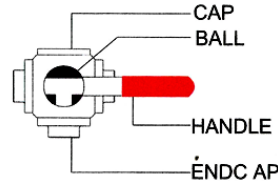

END CONNECTIONS

Screwed BSP

Screwed NPT

Socket Weld

Butt Weld SCH 40

Flanged ANSI 150

Flanged PN16



Easy to Actuate in both
Pneumatic or Electric

